

FASAD A
1:100 (A3)

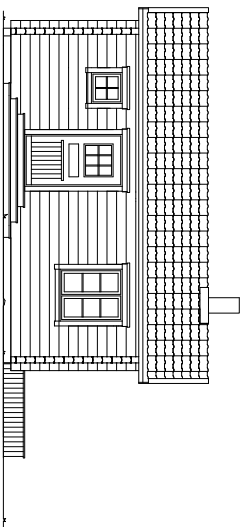

FASAD B
1:100 (A3)

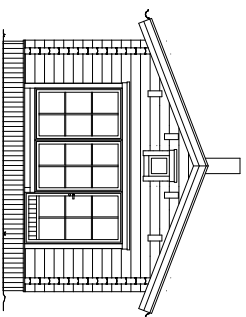

FASAD C
1:100 (A3)

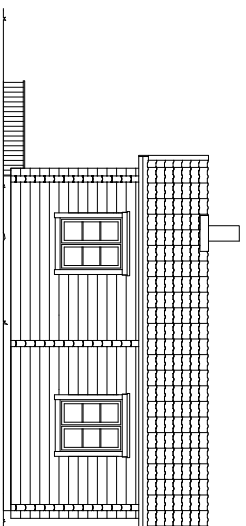

FASAD D
1:100 (A3)

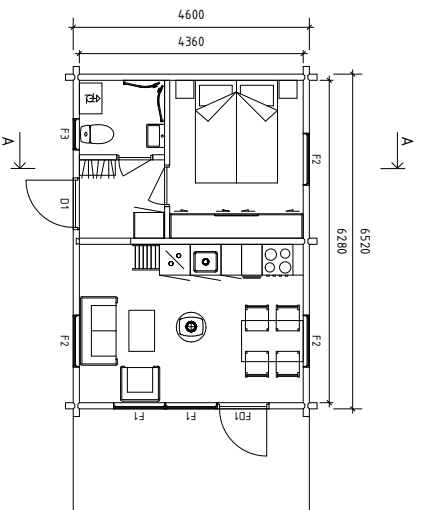

BOTTEPLAN
1:100 (A3)

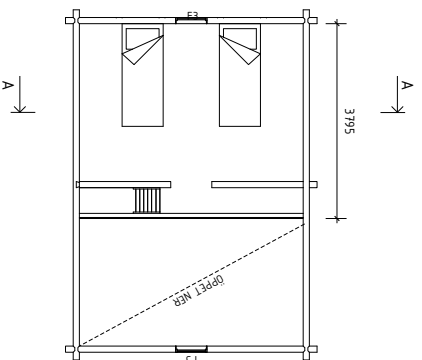

LOFTPLAN
1:100 (A3)

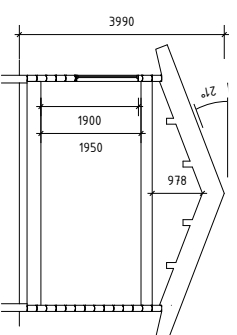

SEKTION A-A (PLINT/TORPARGRUND)
1:100 (A3)

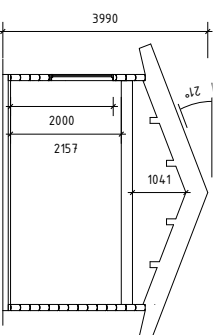

SEKTION A-A (PLATTÅ PÅ MARK)
1:100 (A3)